

# Installation Instructions

LISC-301LG

Please read carefully and save these instructions

**WARNING: ALL INSTALLATION WORK SHOULD BE DONE BY ACCREDITED PROFESSIONAL.  
SHUT OFF POWER SUPPLY AT FUSE OR CIRCUIT BREAKER!**

## PREPARING FOR INSTALLATION

- Carefully remove all contents from the carton. See the important notes above. Shut off the power at the circuit breaker and completely remove the old fixture from the ceiling, including the old mounting plate. Remove the mounting plate assembly from the bag.
- Mounting plate (B) contains several pairs of threaded holes. Find the pair of holes that matches the spacing of the holes on the junction box and the fixture's backplate. Two mounting screws (A) should be attached to mounting plate (B). You may need to tighten nuts (C) to hold these screws in place. Pull the house wires through the center of mounting plate (B). Place mounting plate (B) over the junction box so that mounting screws (A) are vertical and aligned with the hole locations on the fixture's backplate (F). Secure mounting plate (B) to the junction box by tightening the screws (D).

## CONNECTING THE WIRES



- Strip 3/8" of insulation from the wire ends. Using wire connector (AA), connect RIBBED fixture wire to the WHITE supply wire from the junction box; connect the SMOOTH fixture wire to the BLACK supply wire. Connect the fixture ground wire and supply ground wire using a wire connector or by fastening to the ground screw (E) on the mounting plate. Push all wire connections into the junction box.

## FINISHING THE INSTALLATION

- Place the fixture's backplate (F) over the mounting screws (A) so that they protrude through the holes in the front of the backplate. Tightly screw the ball nuts (G) onto the mounting screws (A) until the backplate of the fixture is snug against the wall.
- Secure glass (I) onto the socket (H) by screwing socket ring (J) tight. Install light bulb (not included) in accordance with the fixture's specifications. Do not exceed the recommended maximum wattage.

Your installation is now complete. Turn on the power and test the fixture.

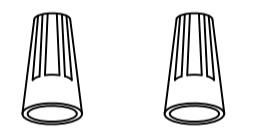
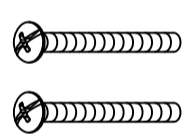
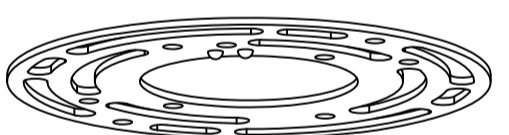
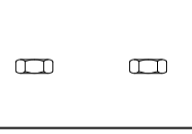
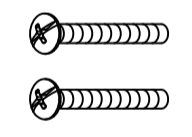
## Accessory package

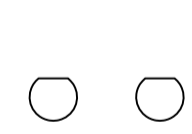
Ⓐ Wire connector		x3
Ⓐ Mounting screws(#8-32*32mm)		x2
Ⓑ Mounting plate		x1
Ⓒ Nuts		x2
Ⓓ Mounting screws(#8-32*25mm)		x2
Ⓔ Ground screw		x1
Ⓕ Ball nuts		x2

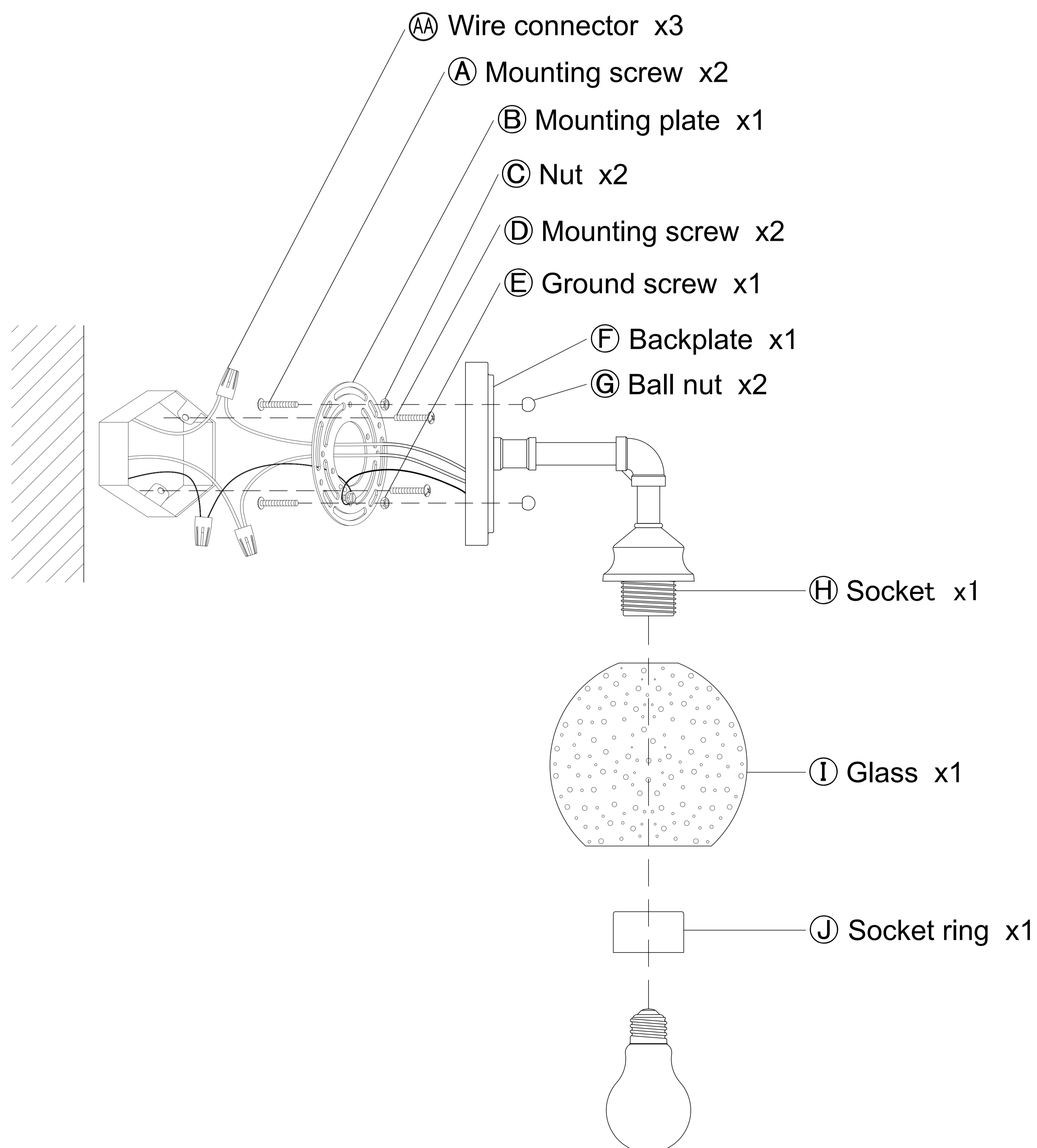
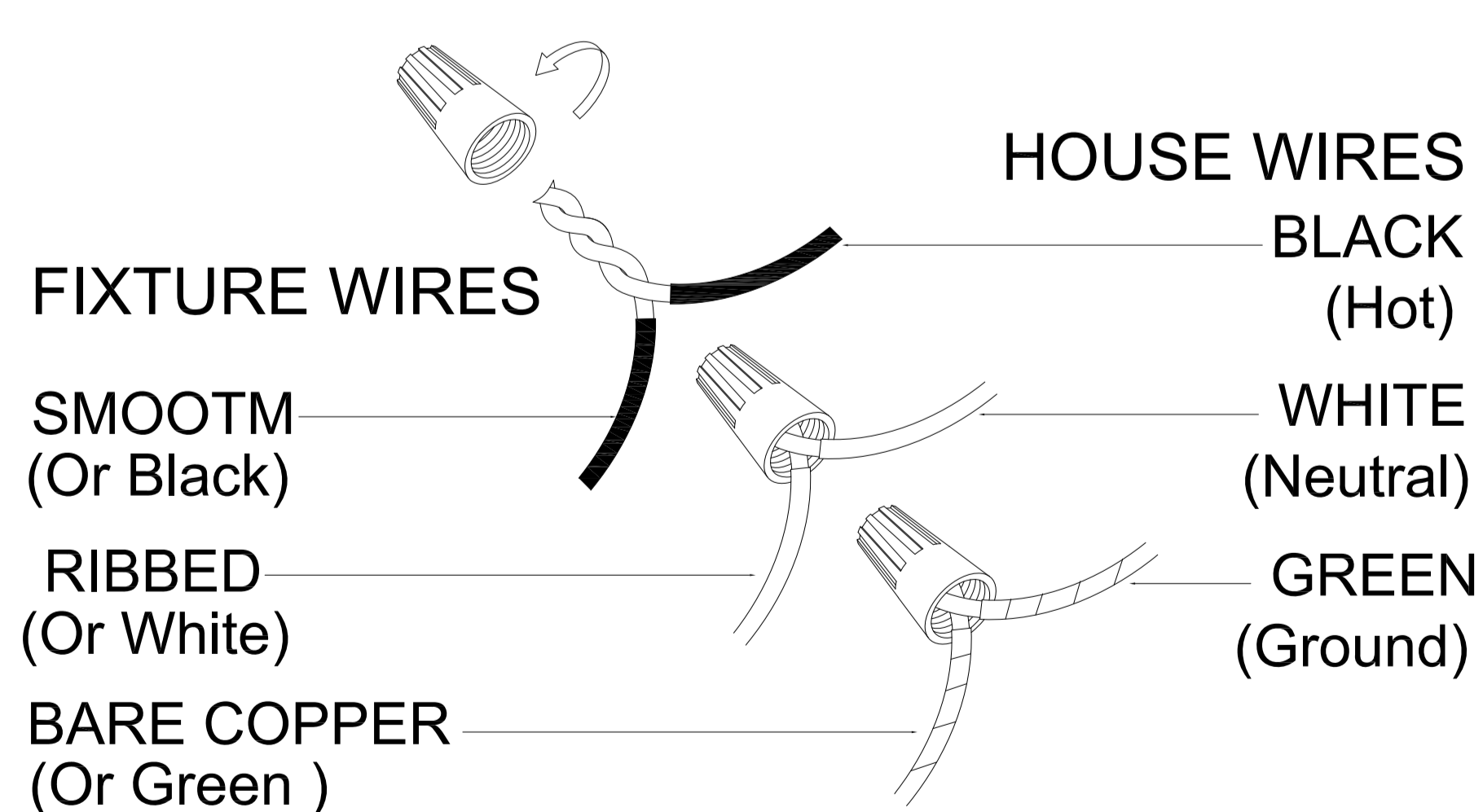

## CLEANING TIPS

Treat the fixture gently! Regular cleaning will reduce the need for deep cleaning. For regular cleaning, turn off the light and wipe down the fixture with a clean lint-free cotton or microfiber cloth. Never spray cleaner directly onto the fixture. Dry with a lint-free or microfiber cloth.